

REWARDING BRIGHTNESS



Downlights

Fluxe 75 LV/RGB
Fixed

Specifications

Colour white	Matt white RAL 9016 (=MW)
Colour grey	Matt grey RAL 9006 (=GR)
Colour black	Matt black RAL 9005 (=BL)
Beam angle (FWHM)	60°
Fixture material	Housing: Die cast aluminium / Reflector glass: Polycarbonate
Environment	Indoor
IP rate	IP20 / IP44
IK rate	IK03
Operating temperature (Ta)	-20°C / +45°C
Safety marks	EN60598 / EN62031 / EN62471
EMC compliance	EN55015
Colour consistency (SDCM)	MacAdam step 3
Warranty	7 Years

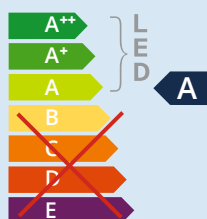

This luminaire contains built-in LED lamps

The lamps cannot be changed in the luminaire.

874/2012



Only when the product is installed in a closed ceiling it may be exposed to water splashes, and only on its front side.

REWARDING BRIGHTNESS

Item specifications (part A)

Description	Item code	Type	Input	W	Lm	Lm/W	CRI (typ.)	UGR	Pf	Ripple	Inrush current	B-16A Fuse
Fluxe 75 LV/RGB 1000 Lm 1800-4000K MW	807303MW0814	Incl. PSU	220-240V	19	1000	52	85-97	23.8	0.93	<3%	5A 50µS	50
Fluxe 75 LV/RGB 1000 Lm 1800-4000K BL	807303BL0814	Incl. PSU	220-240V	19	1000	52	85-97	23.8	0.93	<3%	5A 50µS	50
Fluxe 75 LV/RGB 1000 Lm 1800-4000K GR	807303GR0814	Incl. PSU	220-240V	19	1000	52	85-97	23.8	0.93	<3%	5A 50µS	50
Fluxe 75 LV/RGB 1000 Lm 1800-4000K MW	807303MW0421	Incl. Conn.Box	24Vdc	16	1000	63	85-97	23.8	x	x	x	x
Fluxe 75 LV/RGB 1000 Lm 1800-4000K BL	807303BL0421	Incl. Conn.Box	24Vdc	16	1000	63	85-97	23.8	x	x	x	x
Fluxe 75 LV/RGB 1000 Lm 1800-4000K GR	807303GR0421	Incl. Conn.Box	24Vdc	16	1000	63	85-97	23.8	x	x	x	x

Item specifications (part B)

Description	Safety class	Energy class	Weight	Dimensions single carton	Quantity per carton	Expected lifespan (25°C)		
						L70B50	L80B50	L90B50
Fluxe 75 LV/RGB 1000 Lm 1800-4000K MW	II	A	429 gr	105x105x105 mm	35 pcs	80.000 hrs	70.000 hrs	60.000 hrs
Fluxe 75 LV/RGB 1000 Lm 1800-4000K BL	II	A	429 gr	105x105x105 mm	35 pcs	80.000 hrs	70.000 hrs	60.000 hrs
Fluxe 75 LV/RGB 1000 Lm 1800-4000K GR	II	A	429 gr	105x105x105 mm	35 pcs	80.000 hrs	70.000 hrs	60.000 hrs
Fluxe 75 LV/RGB 1000 Lm 1800-4000K MW	III	A	339 gr	105x105x61 mm	42 pcs	80.000 hrs	70.000 hrs	60.000 hrs
Fluxe 75 LV/RGB 1000 Lm 1800-4000K BL	III	A	339 gr	105x105x61 mm	42 pcs	80.000 hrs	70.000 hrs	60.000 hrs
Fluxe 75 LV/RGB 1000 Lm 1800-4000K GR	III	A	339 gr	105x105x61 mm	42 pcs	80.000 hrs	70.000 hrs	60.000 hrs

All values are measured at 230V (+/- 7%)

Dimensions

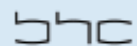
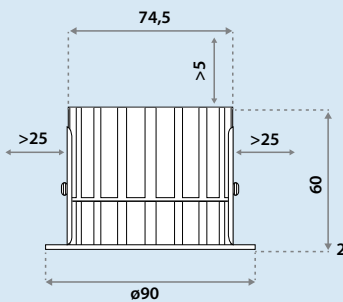

REWARDING BRIGHTNESS

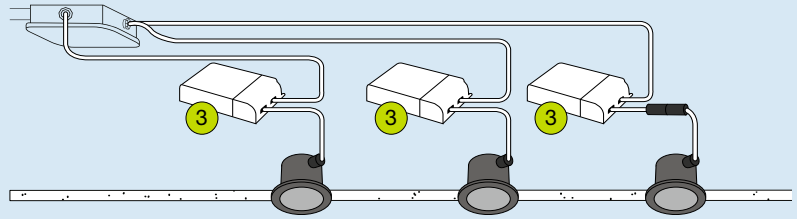

Individual power supply

Description	Item Code	Watt	Voltage	Efficiency	Pf	Ripple	Input Voltage	Weight	Inrush current	B-16A Fuse
PSU 4951 (3)	495105BLTC02	20W	24Vdc	87%	0.93	<3%	110-240V	106 gr	5A 50µS	50 Pcs

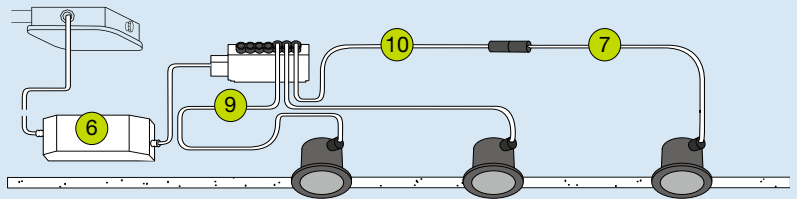

Central power supply

Description	Item Code	Watt	Voltage	Efficiency	Pf	Ripple	Input Voltage	Weight	Inrush current	B-16A Fuse
PSU 7038 (6)	703805000002	70W	24Vdc	91%	0.97	<3%	220-240V	448 gr	15A 600µS	15 Pcs
PSU 7039 (6)	703905000002	150W	24Vdc	94%	0.98	<3%	220-240V	582 gr	35A 1000µS	8 Pcs

Connection cable

Description	Item Code	Voltage	Weight
LV cable 6 way distributor 1,0 m (9)	639305BL0000	24Vdc	63 gr
LV plug to LV plug 2,0 m (7)	565205BL1200	24Vdc	38 gr
LV plug to outlet 2,0 m (extension cable) (10)	535205BL1200	24Vdc	34 gr

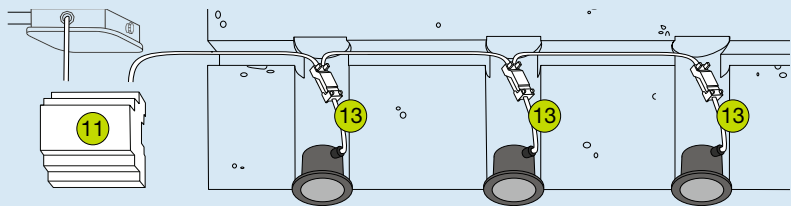

Central DIN rail power supply

Description	Item Code	Watt	Voltage	Efficiency	Pf	Ripple	Input Voltage	Weight	Inrush current
PSU MW DR60 (11)	704005000002	60W	24Vdc	84%	0.92	<3%	220-240V	296 gr	35A
PSU MW DR100 (11)	704105000002	100W	24Vdc	89%	0.92	<3%	220-240V	342 gr	45A

Connection cable

Description	Item Code	Voltage	Weight
LV plug to connection box 0,2 m (13)	555205BL0000	24Vdc	32 gr

Instruction manual BLE-ND

This instruction manual provides the information to get started with the BLE-ND APP from the installation to the final configuration of the BLE ledspots.

1) Installing BLE-ND APP

To control BLE spots the BLE-ND APP is available in the APP store and can be found by entering “ble-nd” in the search area. The APP requires iOS 8.0 or newer.

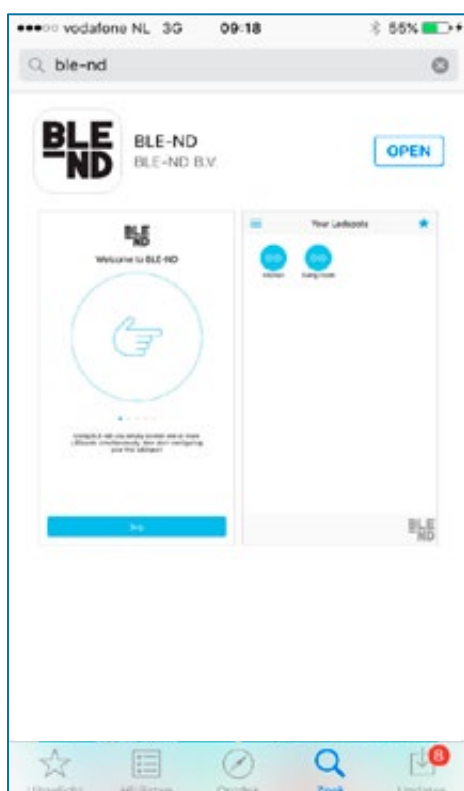

figure 1: BLE-ND APP in Appstore

2) First time use

When the APP is being used for the first time, a short tutorial is shown which explains the basic functionality.

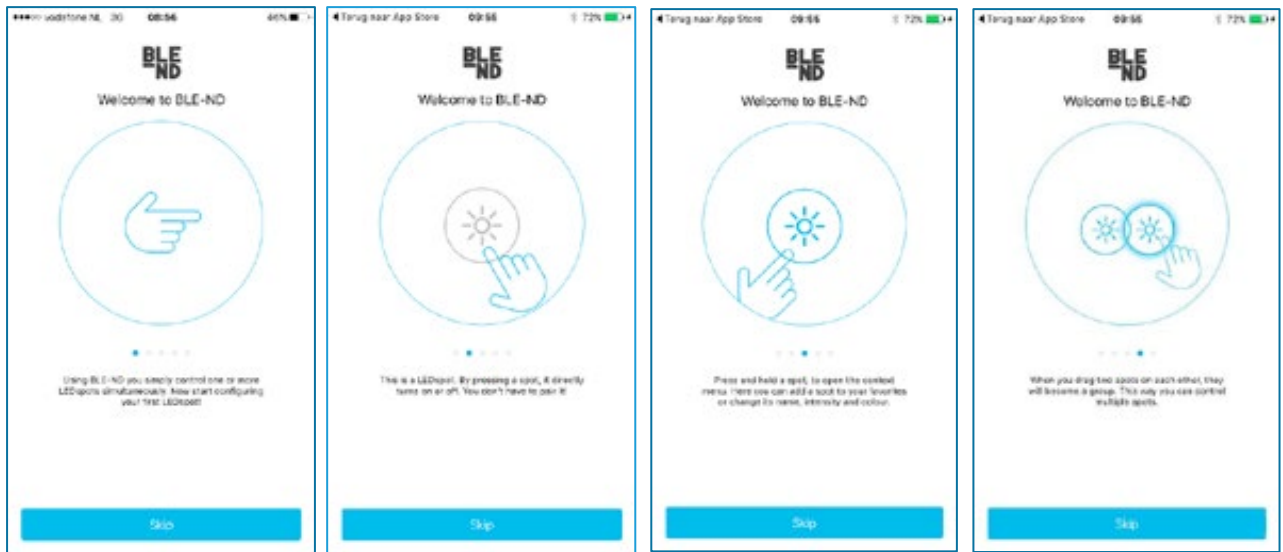

figure 2: tutorial screens

3) Your Ledspots

After the tutorial the “your ledspots” main screen is shown (figure 3). This screen will be shown every time the APP is started. Note that ledspots should always be configured in the APP before use.

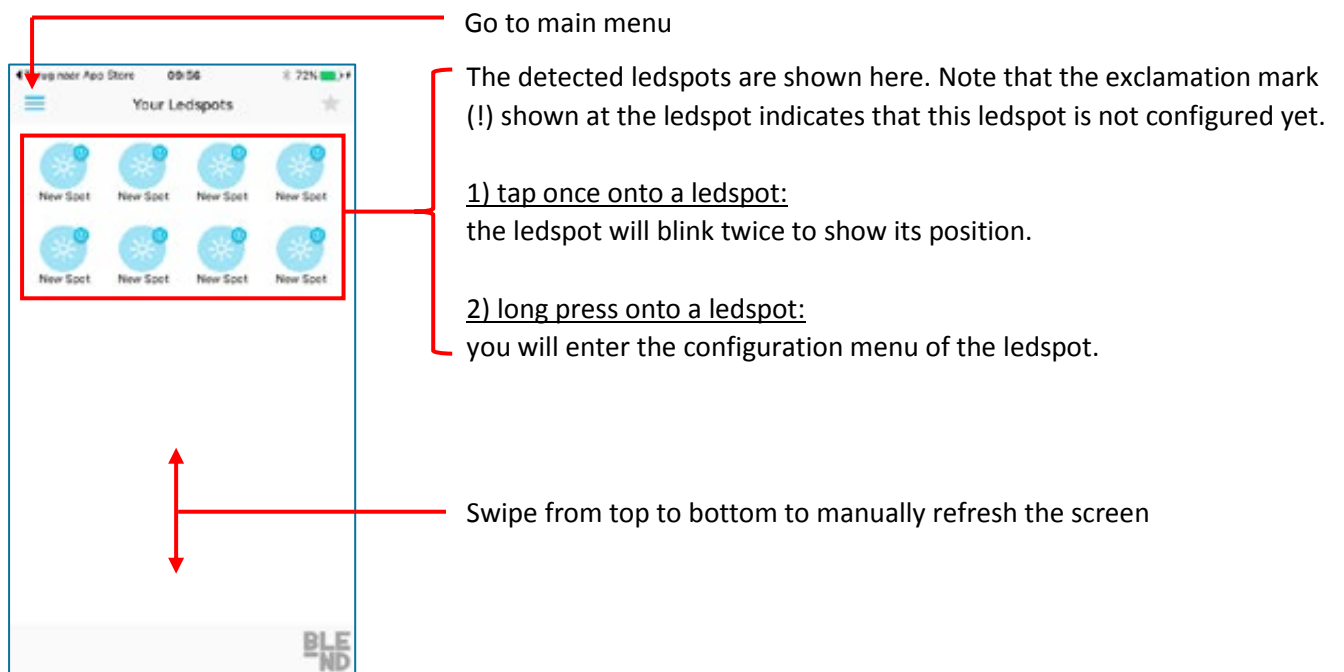

figure 3: “your ledspots” main screen

4) Configuring ledspots

With a long-press onto an unconfigured ledspot, the configuration menu is shown. Here the spot can be given a certain name, color and intensity. The configuration will automatically be saved when the back symbol (“<”) is pressed.

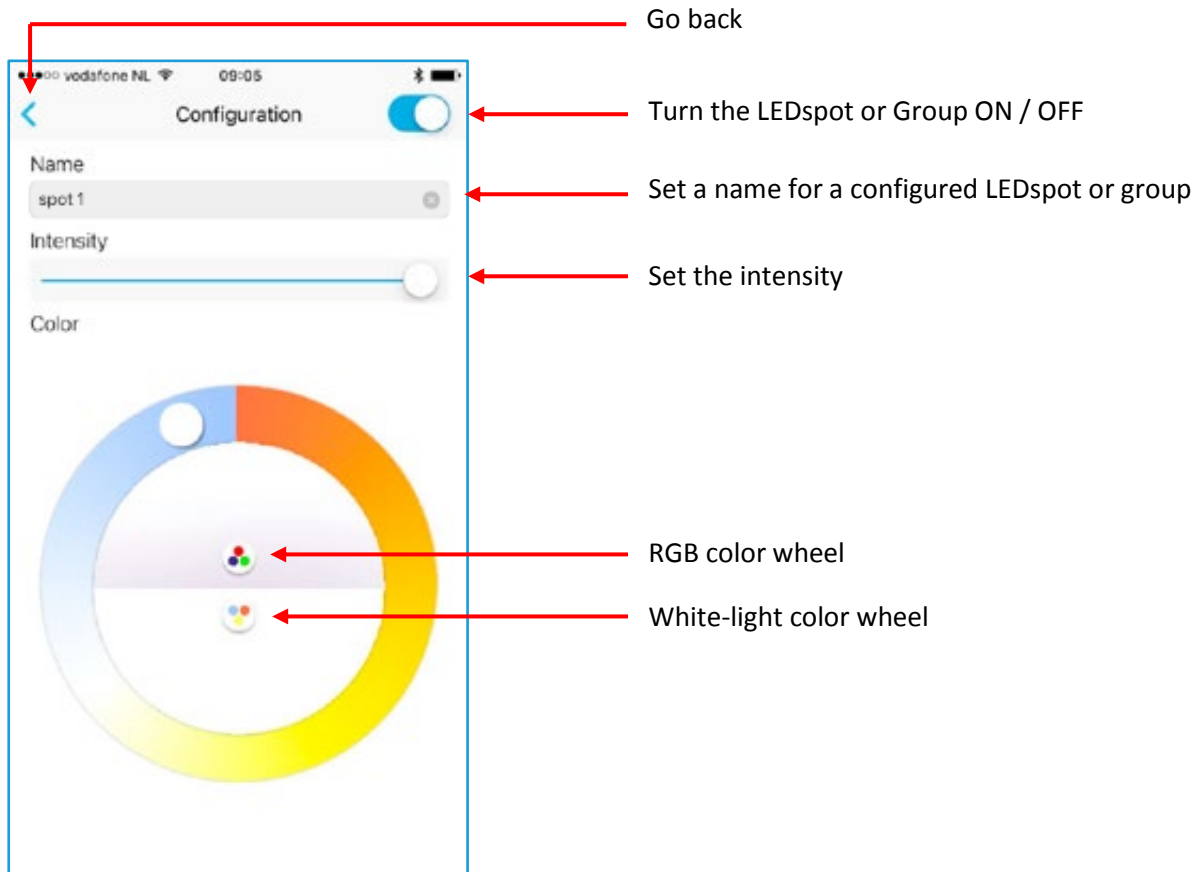

figure 4: configuration screen

When a spot is configured, the exclamation mark is removed as shown below.

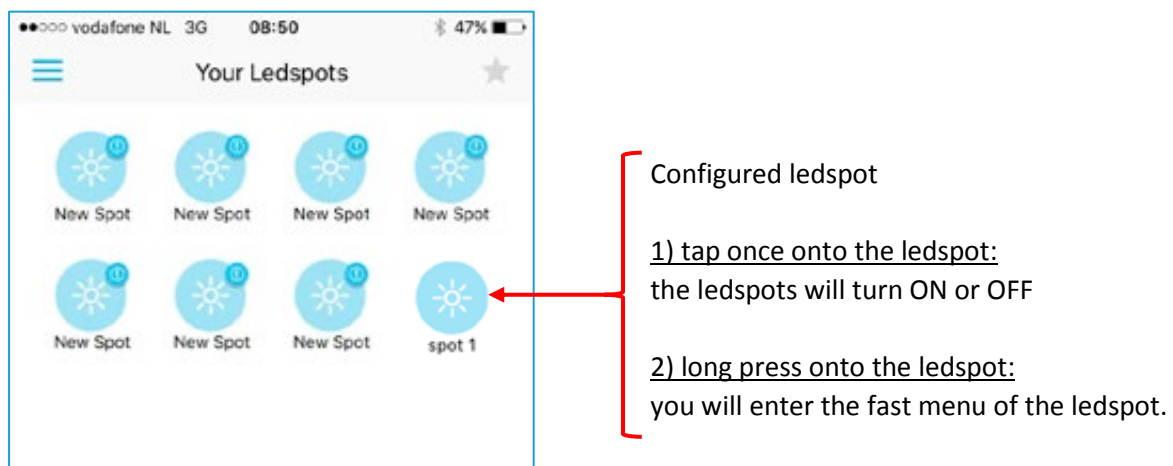
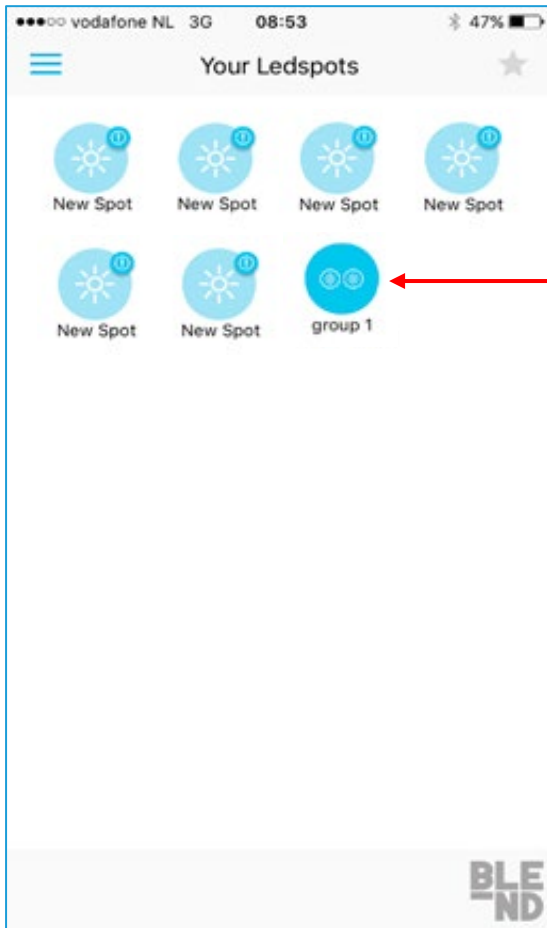

figure 5: main screen with configured ledspot

5) Make groups

Groups can only be made with configured ledspots by dragging a configured ledspot over another ledspot. When doing so, the configuration window is shown where a group name, color and intensity can be set. A group can consist of a minimum of 2 and a maximum of 6 ledspots.



Group symbol

1) tap once onto a group:
the group of ledspots will turn ON or OFF

2) long press onto a group:
you will enter the fast menu of the group.

figure 6: main screen with configured group

6) Fast Menu

The fast menu will be shown after a long-press onto a configured ledspot or group.

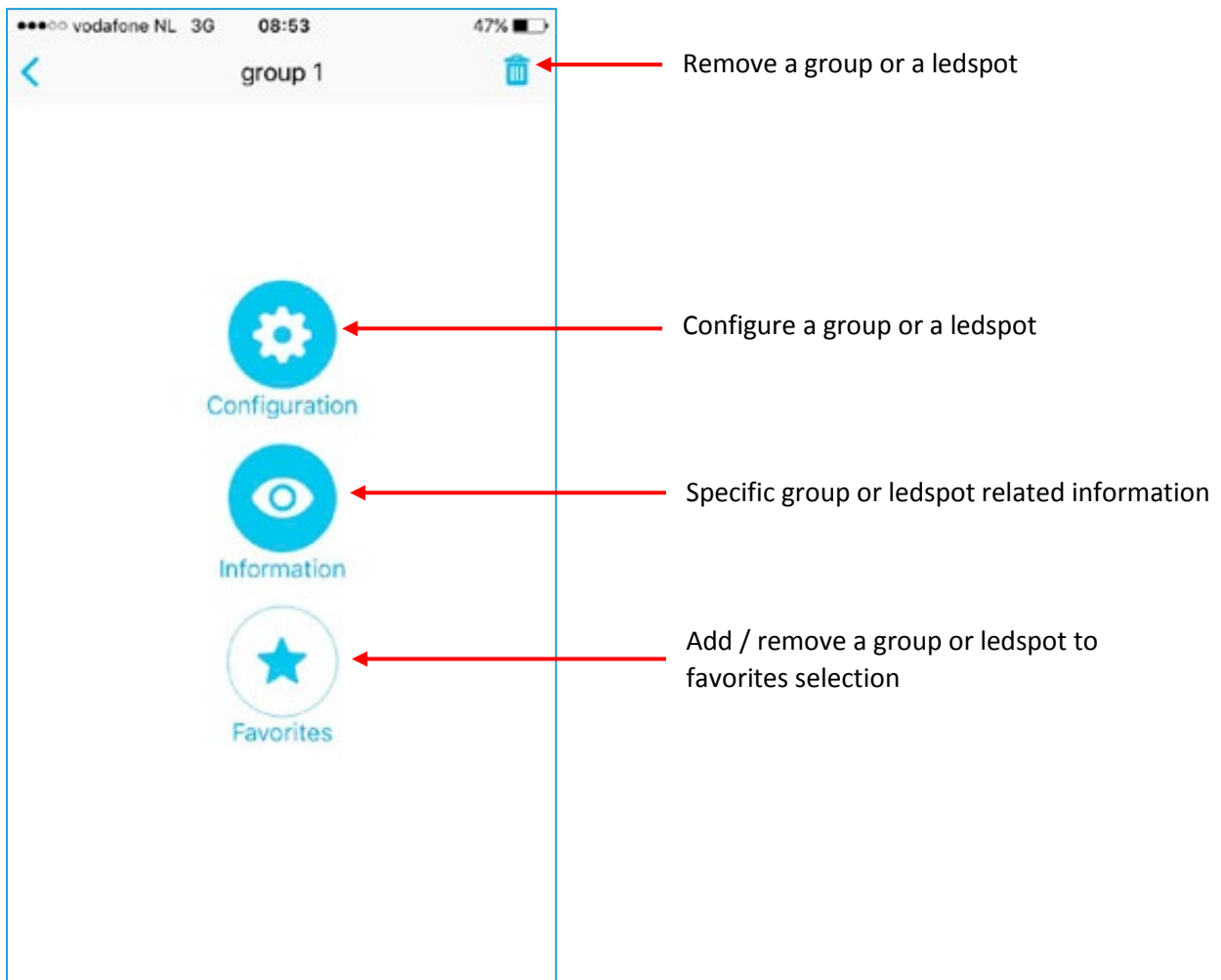

figure 7: fast menu

7) Remove a group or single ledspot

Remove group at once

A ledspot or group can be removed via the fast menu. When removing a group of ledspots, all spots in the group will be removed at once. The removed ledspots will be shown again in the "your ledspots" main screen (figure 3).

Remove specific ledspots from a group

Specific ledspots can be removed from a group via the “Information” button.

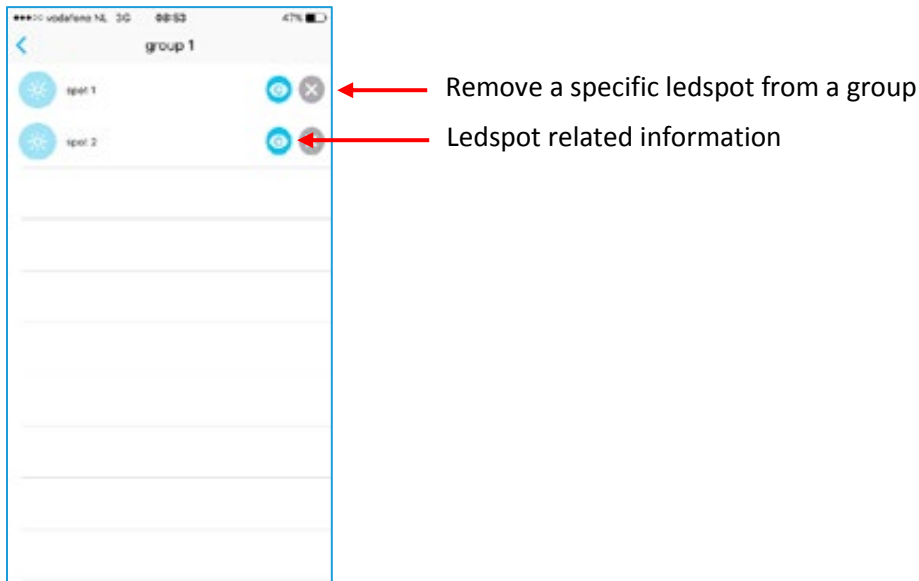

figure 8: information screen

Remove single ledspots

When a single ledspot is removed, it will be shown in the “your ledspots” main screen as unconfigured ledspots (“new spot”).

8) Favorites

Ledspots or groups can be added to favorites via the fast menu (figure 7) by pressing the “Favorites” symbol.

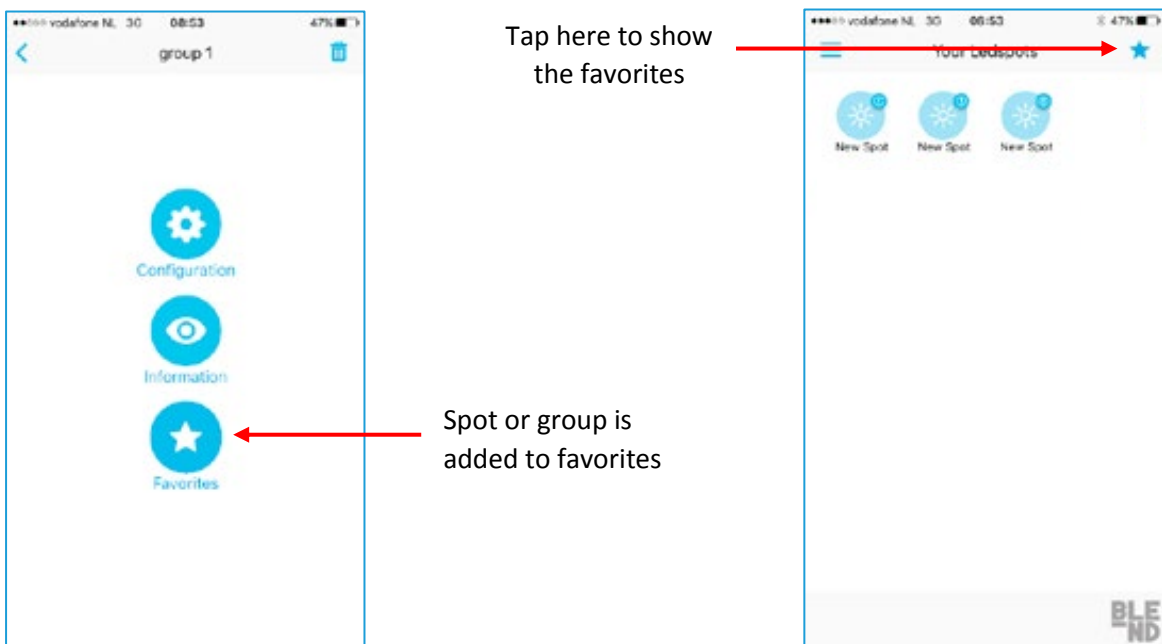

figure 9: favorites in fast menu and main screen

The spots or groups which are added to favorites can be shown via the favorites icon in the main screen.

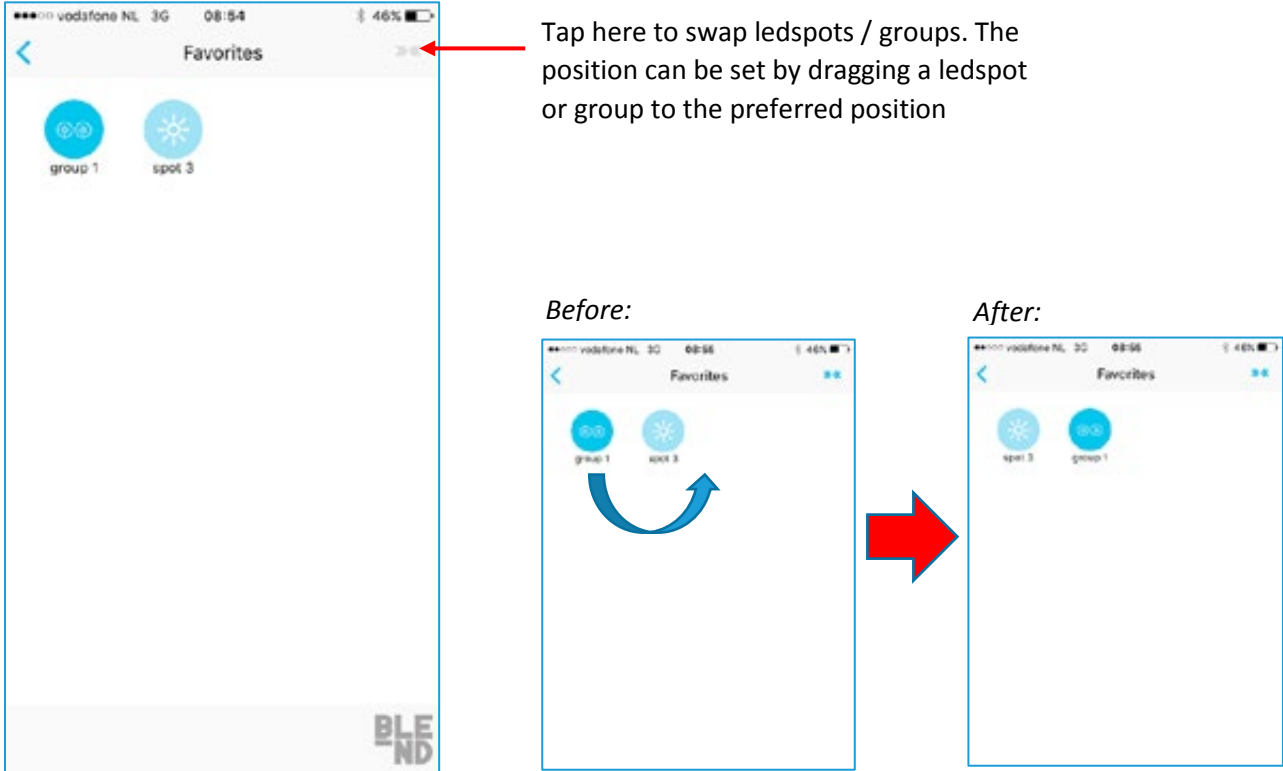







figure 10: swap functionality in favorites screen

When the swap-icon is in OFF state, the same functionality is available as in the main screen (configure ledspots, make groups etc.).

9) Overview symbols & indicators

Symbol	Meaning	How to solve?
 New Spot	Unconfigured ledspot.	Long press onto the ledspot to go to the configuration menu
 spot 1	Configured ledspot	
 spot 1	Configured ledspot which is not powered or out of range.	Power the ledspot or decrease the distance between the smartphone and the ledspot.
 group 1	Configured group	
 group 1	Configured group with 2 ledspots which are out of range.	Decrease the distance between the smartphone and the ledspots.

Important note:

The red circle shows the amount of ledspots in a group which are out of range. This indicator is NOT real-time and will only be updated during a manual refresh (figure 3).